

Power lock devices

For applications where the need for a secure connection is absolute

Power lock devices are designed for safety, energizing within a chamber to eliminate the possibility of exterior arcing. They are ideal for high-abuse industrial and specialized hospital applications

Nylon power lock plugs & connectors features & benefits

High-impact nylon shell ideal for use in high abuse installations

Neoprene gasket seals cord entry hole and prevents dust and moisture from entering terminal area

Tapered cord grip cover prevents cord snagging

Unique twist type cover eliminates assembly screws

Carefully machined contacts of high alloy brass molded into high impact resistant fiberglass reinforced nylon

Totally insulated design eliminates exposed metal parts

Innovative cord clamping fingers provide exceptional cord retention

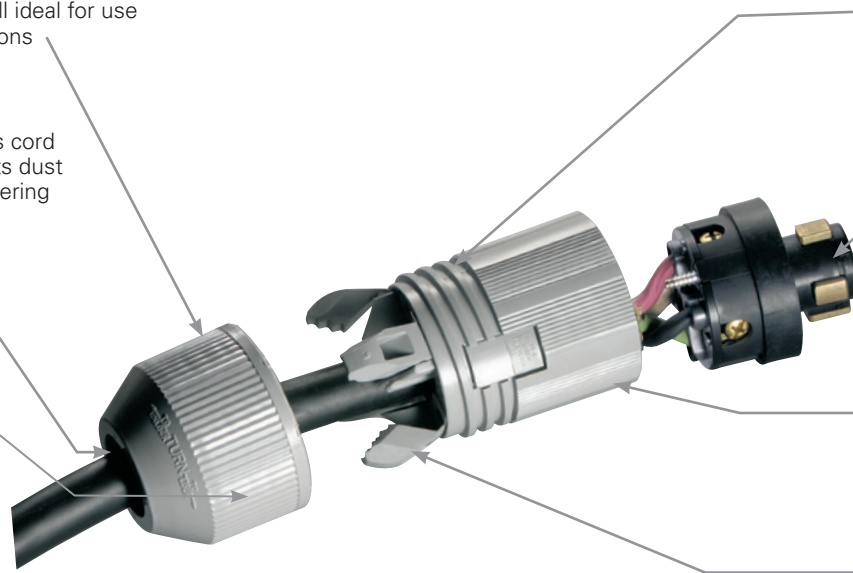

Armored power lock plugs & connectors features & benefits

Adjustable external metal cord grip accepts a wide range of cord diameters

Neoprene grommet protects against contamination

Spring loaded safety shutter ejects the plug if not fully locked in and prevents entrance of foreign matter

Large pressure plate terminals for ease of wiring

Rugged steel shell for maximum protection

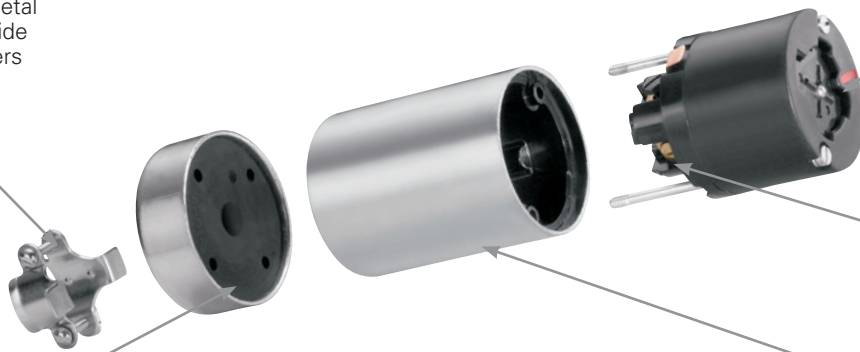

Power lock hospital use locking devices

Product description

2-pole, 3-wire grounding
20A, 125V/AC
Non-NEMA

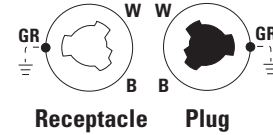

23054

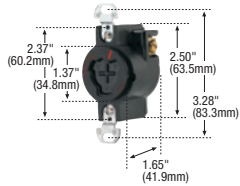

23050



25525

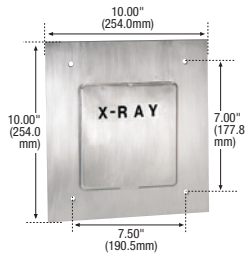

25505

Hospital use, back wire, plugs & connectors

Rating A	V/AC	Description	Cord diameter	Color	Plug catalog no.	Connector catalog no.	
20	125	Nylon "dead front" design	0.33-0.66" (8.4-16.7mm)	GY	<input type="checkbox"/> 23056N	<input type="checkbox"/> 23054N	•
		Armored "dead front" design	0.33-0.66" (8.4-16.7mm)	GY	<input type="checkbox"/> 23056	<input type="checkbox"/> 23054	•

Hospital use receptacles

Rating A	V/AC	Description	Color	Single receptacle	
20	125	Receptacle, not for use in hazardous areas	BK	<input type="checkbox"/> 23050	• •

Power lock hospital use mobile x-ray devices

Product description

2-pole, 3-wire grounding
50A & 60A, 250V/AC
Non-NEMA

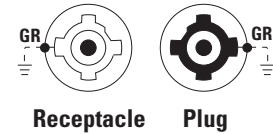

Hospital use, back wire, plugs & connectors

Rating A	V/AC	Description	Cord diameter	Color	Plug catalog no.
50	250	"Dead front" design	0.75-1.25" (19.1-31.8mm)	GY	<input type="checkbox"/> 25525
60	250	"Dead front" design	0.75-1.25" (19.1-31.8mm)	GY	<input type="checkbox"/> 25625

Hospital use receptacles

Rating A	V/AC	Description	Color	Single receptacle	
50	250	Receptacle in plate assembly	Stainless steel	<input type="checkbox"/> 25505	•
60	250	Receptacle in plate assembly	Stainless steel	<input type="checkbox"/> 25605	•

Accessories for power lock hospital use locking devices

Description	Catalog no.
Steel 50A receptacle wallbox, KO sizes 1.25" (31.9mm), 1.50" (38.1mm), 2" (50.8mm)	<input type="checkbox"/> 25509



25509

Color information:

BK (Black), GY (Gray)

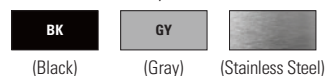

Dimensional information:
C-81

Plug specification information:
Hospital power lock: C-93

Receptacle specification information:
Hospital power lock: C-93

Compliances, specifications and availability are subject to change without notice.

Power lock devices

Power lock industrial grade locking devices

Product description

2-pole, 3-wire grounding
20A, 125V/AC
Non-NEMA

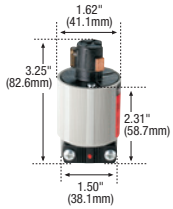
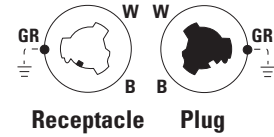

23035N



23032N

Industrial grade, back wire plugs & connectors

Rating A	V/AC	Description	Cord diameter	Color	Plug catalog no.	Connector catalog no.
20	125	Nylon "dead front" design	0.33-0.66" (8.4-16.7mm)	GY	<input type="checkbox"/> 23035N	<input type="checkbox"/> 23032N

Power lock industrial grade locking devices

Product description

3-pole, 3-wire grounding
& non-grounding
20A, 125V/AC
Non-NEMA

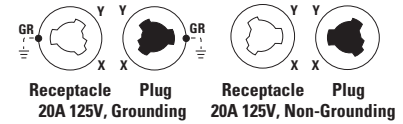

Industrial grade, back wire plugs & connectors

Rating A	V/AC	Description	Color	Flanged inlet	Flanged inlet w/ lid
20	125	Nylon "dead front" design	GY	<input type="checkbox"/> 23005N	<input type="checkbox"/> 23002N

Note: Also rated at 10A for 250V DC and 480V/AC

Industrial grade, receptacles

Rating A	V/AC	Description	Color	Single receptacle
20	125	Standard industrial	BK	<input type="checkbox"/> 23000
		Grounding industrial, replacement only	BK	<input type="checkbox"/> 23000G ^{††}

^{††}Only UL Listed

Dimensional information:
C-82, C-83

Plug & connector specification information:

Power lock: C-94

Receptacle specification information:

Power lock: C-95

Color information:

BK (Black), GY (Gray)

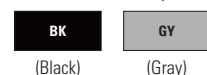

Power lock industrial grade locking devices

Product description

3-pole, 4-wire grounding
20A, 250V/DC; 30A, 600V/AC
Non-NEMA

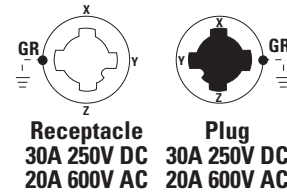

20414N



20415S

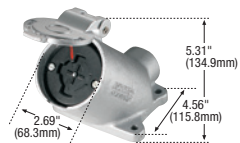

AH21420

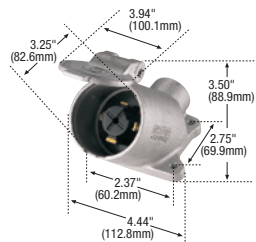

21447

Industrial grade plugs & connectors



A	Rating V/DC	V/AC	Description	Cord diameter	Color	Plug catalog no.	Connector catalog no.	
20/ 30	250	600	Auto grip nylon	0.44-1.06" (11.1-26.0mm)	GY	□ 20415N	□ 20414N	•
			Armored w/ sliding rubber cord grip	0.36-0.48" (9.1-12.3mm)	Steel	□ 21415	□ 21414	
			Armored w/ sliding rubber cord grip	0.48-0.75" (12.3-19.1mm)	Steel	□ 21426	□ AH21427	
			Armored w/ sliding rubber cord grip & special mounting stud ^d	0.48-0.75" (12.3-19.1mm)	Steel	□ 21426S	—	
			Armored w/ sliding rubber cord grip	0.56-1.00" (14.3-25.4mm)	Steel	□ 20415	□ 20414	•
			Armored w/ sliding rubber cord grip & special mounting stud ^d	0.56-1.00" (14.3-25.4mm)	Steel	□ 20415S	—	•
			Armored female	0.75" (19.1mm)	Steel	□ AH21436	—	
			Armored female	0.75" (19.1mm)	Steel	—	□ 21434 ^{††}	

^dUsed in automotive welding applications, ^{††}Only UL Listed

Industrial grade receptacles



A	Rating V/DC	V/AC	Description	Color	Single receptacle	
20/ 30	250	600	Receptacles	BK	□ 20403N	•
			In angled cast aluminum cover w/ weather protective life lid	BK	□ AH21420	

Industrial grade inlets



A	Rating V/DC	V/AC	Description	Color	Inlet catalog no.
20/ 30	250	600	Inlet for FS/FD boxes	BK	□ 20418
			Angled surface mount w/ weather protective lift lid tapped for 0.75" (19.1mm) pipe thread, diecast aluminum		□ 21447

Accessories for 50A locking devices & power lock devices in FS/FS boxes

Description	Color	Catalog no.
Glass-filled nylon lift lid cover for 50A locking devices	Y	□ 7788CR
Glass-filled nylon lift lid cover for 4-wire 30A receptacles	GY	□ 20416N ^d

^dOnly CSA and UL Listed



7788CR



20416N

Dimensional information:
C-82, C-83

Plug & connector specification information:

Power lock: C-94

Receptacle specification information:

Power lock: C-95

Inlet specification information:
Power lock: C-94

Color information:

BK (Black), GY (Gray)

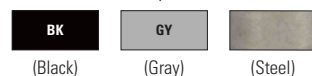

Compliances, specifications and availability are subject to change without notice.

Power lock devices

Power lock industrial grade locking devices

Product description

3-pole, 4-wire grounding
30A, 480V/AC
Non-NEMA

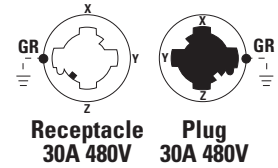

Industrial grade plugs & connectors

Rating A	V/AC	Description	Cord diameter	Color	Plug catalog no.	Connector catalog no.	
30	480	Auto grip nylon	0.40-1.06" (10.2-27.0mm)	RD	□ 20445N	□ 20444N	•
		Armored	0.49-0.61" (12.3-15.5mm)	RD	□ 20445	□ 20444	•

Industrial grade receptacles

Rating A	V/AC	Description	Color	Single receptacle	
30	480	Industrial receptacles	BK	□ 20443N	•

Accessories for 50A locking devices & power lock devices in FS/FS boxes

Description	Color	Catalog no.
Glass-filled nylon lift lid cover for 50A locking devices	Y	□ 7788CR
Glass-filled nylon lift lid cover for 4-wire 30A receptacles	GY	□ 20416N ¹

¹Only CSA and UL Listed



20445N



20444N

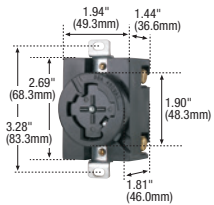

20443N



7788CR



20416N

Dimensional information:
C-82, C-83

Plug & connector specification information:
Power lock: C-94

Receptacle specification information:
Power lock: C-95

Color information:

BK (Black), RD (Red)



Compliances, specifications and availability are subject to change without notice.

Power lock industrial grade locking devices

Product description

3-pole, 4-wire grounding
60A, 600V/AC
Non-NEMA

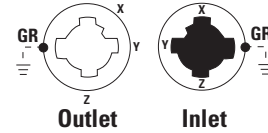

26415



26414



26420



26415A

Industrial grade plugs & connectors



Rating	A	V/AC	Description	Cord diameter	Color	Plug catalog no.	Connector catalog no.
60	600		Armored	0.75-1.25" (19.1-31.8mm)	Y	□ 26415	□ 26414
			Armored w/ special mounting stud	0.75-1.25" (19.1-31.8mm)	Y	□ 26415S	—
			Armored w/ rubber bushing in cable clamp	0.75-1.25" (19.1-31.8mm)	Y	□ 26426	□ 26427
			Armored w/ rubber bushing in cable clamp & special mounting stud [†]	0.75-1.25" (19.1-31.8mm)	Y	□ 26426S	—

[†]Used in automotive welding applications
Note: Bushing versions supplied with 3 sizes of rubber bushings

Industrial grade receptacles



Rating	A	V/AC	Description	Color	Single receptacle
60	600		In cast aluminum cover w/ weather protective life lid	BK	□ 26420
			In angled cast aluminum cover w/ weather protective life lid	BK	□ 26421**

** Not CSA certified

Industrial grade flanged inlets & outlets



Rating	A	V/AC	Description	Cord diameter	Color	Flanged inlet	Flanged outlet
60	600		Armored flange	0.75-1.25" (19.1-31.8mm)	Steel	□ 26415A	□ 26414A

Dimensional information:
C-82, C-83

Plug & connector specification information:

Power lock: C-94

Receptacle specification information:

Power lock: C-95

Inlet specification information:
Power lock: C-94

Color information:

BK (Black), Y (Yellow)



Power lock devices

Power lock industrial grade locking devices

Product description

4-pole, 5-wire grounding
20A, 250V/DC; 30A, 600V/AC
Non-NEMA

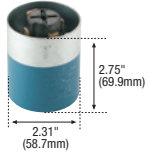
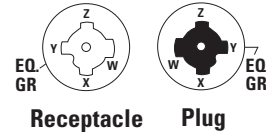

25415

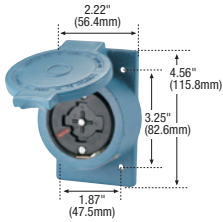

25250

Industrial grade plugs & connectors

A	Rating		Description	Cord diameter	Color	Plug catalog no.	Connector catalog no.	
V/DC	V/AC							
20/30	250	600	Auto grip nylon	040-1.06" (10.2-27.0mm)	BL	□ 25415N	□ 25414N	•
			Armored	0.62-1.00" (15.9-25.4mm)	BL	□ 25415	□ 25414	•

Industrial grade receptacles

A	Rating		Description	Color	Single receptacle
V/AC	V/AC				
20/30	250	600	In cast iron cover and steel shell	BK	□ 25403
			In cast aluminum cover w/ weather protective lift lid	BK	□ 25250

Dimensional information:
C-82, C-83

Plug & connector specification information:

Power lock: C-94

Receptacle specification information:

Power lock: C-95

Inlet specification information:

Power lock: C-94

Color information:

BK (Black), BL (Blue)

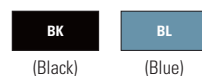

Compliances, specifications and availability are subject to change without notice.

Power lock industrial grade locking devices

Product description

4-pole, 5-wire grounding
60A, 600V/AC
Non-NEMA

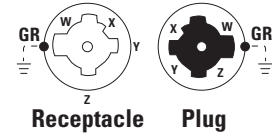

26527



26526

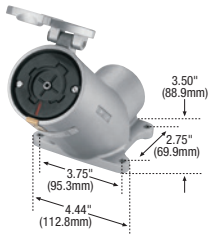

26521



26514A

Industrial grade plugs & connectors

Rating	A	V/AC	Description	Cord diameter	Color	Plug catalog no.	Connector catalog no.	
60	600		Armored	0.75-1.25" (19.1-31.8mm)	Y	□ 26515	□ 26514	
			Armored w/ rubber bushing in cable clamp	0.75-1.25" (19.1-31.8mm)	Y	□ 26526	□ 26527	
			Armored, accepts ring terminals	N/A	BK	□ 26515AM ^a	—	

^a RU Listed only

Note: Bushing versions supplied with 3 sizes of rubber bushings

Industrial grade receptacles

Rating	A	V/AC	Description	Color	Single receptacle
60	600		In cast aluminum cover w/ weather protective life lid	BK	□ 26520
			In angled cast aluminum cover w/ weather protective life lid	BK	□ 26521**

** Not CSA certified

Industrial grade flanged inlets & outlets

Rating	A	V/AC	Description	Cord diameter	Color	Flanged inlet	Flanged outlet	
60	600		Armored flange	0.75-1.25" (19.1-31.8mm)	Steel	□ 26515A	□ 26514A	

Dimensional information:
C-82, C-83

Plug & connector specification information:
Power lock: C-94

Receptacle specification information:
Power lock: C-95

Inlet specification information:
Power lock: C-94

Color information:

BK (Black), Y (Yellow)



Compliances, specifications and availability are subject to change without notice.

Power lock industrial grade locking devices

Product description

Accessories for
30A, 60A devices

Receptacle accessories for power lock nylon plates

Rating	Description	Catalog no.	
A			
30	Red glass-filled nylon with weather protective lift lid cover and gasket, suitable for wet and damp locations with cover closed	<input type="checkbox"/> 20446N	•
	Gray glass-filled nylon with weather protective lift lid cover and gasket, suitable for wet and damp locations with cover closed	<input type="checkbox"/> 20416N	•

Receptacle accessories for power lock aluminum plates

Rating	Description	Catalog no.
A		
30	Diecast aluminum with weather protective lift lid cover and gasket	<input type="checkbox"/> 20416D
	Diecast aluminum cover without lid and gasket	<input type="checkbox"/> 20417N

Receptacle accessories for power lock aluminum plates

Rating	Description	Catalog no.
A		
60	Box, only for use with 26040 angle adapter	<input type="checkbox"/> 26401
	Cover, only for use with 26401 box	<input type="checkbox"/> 26402
	Box and cover complete	<input type="checkbox"/> 26400
	45° angle adapter	<input type="checkbox"/> 26040

60A for use with 26420 & 26520 receptacles

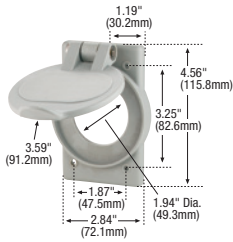

20416N

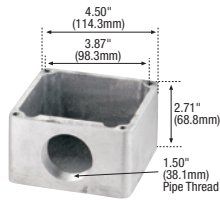

26401

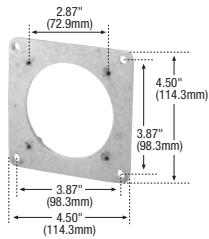

26402